



## Fabric Wall Panel



The trusted classic. We love the simplicity of our functional fabric-wrapped acoustic wall panels. Call it like it is, right? A cost-effective and known solution to controlling noise in any space, these come in various standard sizes and are offered in several thickness options to accommodate all budgets.

---

# Specifications

<b>Product Name</b>	Mode Acoustic Fabric Wall Panel
<b>Shape</b>	Rectangles, squares, circles, hexagons, triangles. Custom shapes available.
<b>Content</b>	6–7lb fiberglass board with optional tackable & high-impact resistant facers, 100% post-consumer recycled polyester fabric
<b>–Thickness</b>	1” and 2“
<b>Unit Width</b>	Up to 60”
<b>Unit Height</b>	Up to 120”
<b>Weight</b>	1” = .8 lbs/sq ft, 2” = 1.5 lbs/sq ft
<b>Edge Options</b>	Square or Beveled
<b>Sound Performance</b>	ASTM C423-17: NRC 1" = 0.80 and 2" = 1.05
<b>Fire Performance</b>	ASTM 84 Class A
<b>Environmental</b>	Low VOC emissions, woven fabrics are FR (Flame Retardant) free and compliant with CAL AB 2998.
<b>Maintenance</b>	Vacuum to remove any loose dirt or dust. You may use a soft or plastic bristle brush to loosen it. Avoid excess pressure. Compressed air can also be used to dust the material in difficult or large installations. Remove ordinary dirt and smudges with a mild soap and water solution and a clean, soft cloth or towel. Dry with a soft lint-free cloth or towel. A melamine magic eraser can be used for more difficult stains. Always apply any cleaning methods to a small area first to test effectiveness and result.
<b>Warranty</b>	5 years
<b>Unit of Sale</b>	Per square foot

# Construction & Hardware

Rotofast snap-on anchor

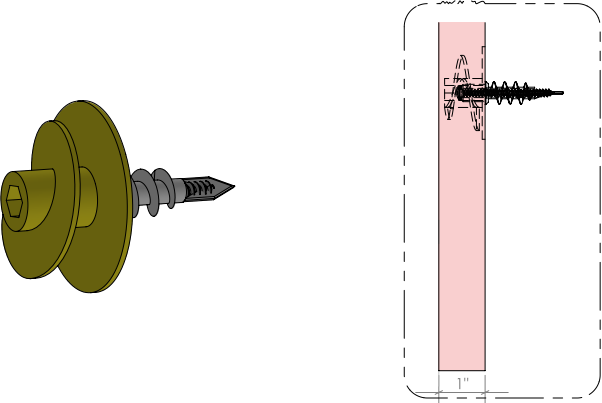

Impaler

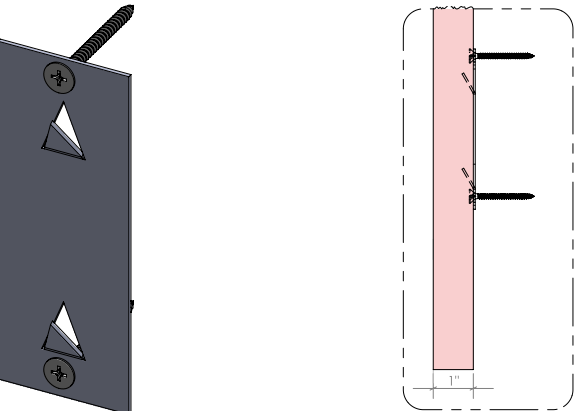

Z Clip

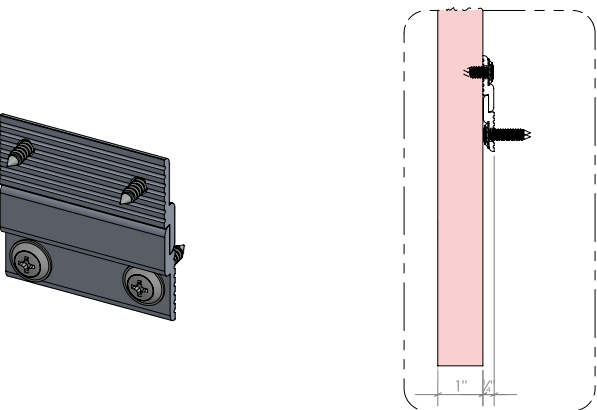

# Colors

We currently offer over 40 standard colors thanks to our partnership with Burch. See our Mode Standard Fabrics document on the next page for a complete listing.

We also carry a wide array of other acoustic fabrics and colors by Guilford of Maine, Knoll, Maharam, and more.

## Test Results

### 1" Fabric Flat Panel

Absorption Coefficient vs. Freq (Hz)

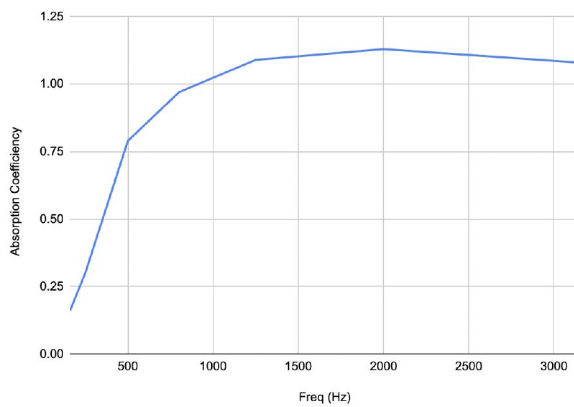

Freq (Hz)	Absorption Coefficient
-----------	------------------------

160	0.16
-----	------

250	0.30
-----	------

500	0.79
-----	------

800	0.97
-----	------

1250	1.09
------	------

2000	1.13
------	------

3150	1.08
------	------

<b>NRC</b>	<b>0.80</b>
------------	-------------

### 2" Fabric Flat Panel

Absorption Coefficient vs. Freq (Hz)

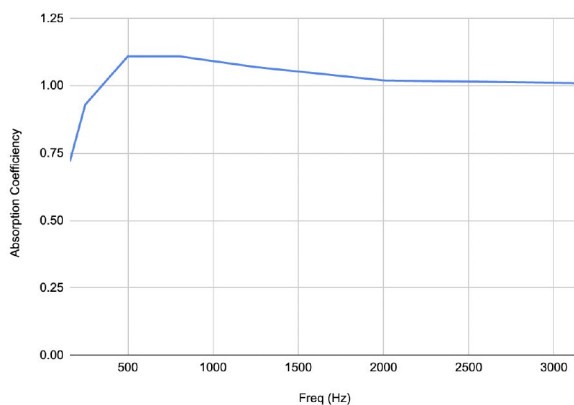

Freq (Hz)	Absorption Coefficient
-----------	------------------------

160	0.72
-----	------

250	0.93
-----	------

500	1.11
-----	------

800	1.11
-----	------

1250	1.07
------	------

2000	1.02
------	------

3150	1.01
------	------

<b>NRC</b>	<b>1.05</b>
------------	-------------

The Noise Reduction Coefficient (NRC) is calculated as the arithmetic average of the absorption coefficients in the shaded bands only (250, 500, 1250 & 2000 Hz).

ASTM C 423-17: The specimens were tested in a Type A mounting, as defined by ASTM Practice B 795-05. Specimens were placed directly on the reverb room floor. The specimens had a 1" aluminum frame butted against them with the frame duct taped to the floor.



Tangerine



Paprika



Shiraz



Scarlet

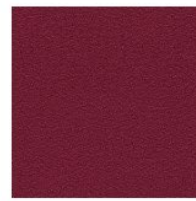

Fuchsia



Violet



Admiral



Marina



Azure



Peacock

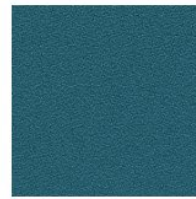

Tropic



Chambray



Aloe



Key Lime



Spring



Spruce

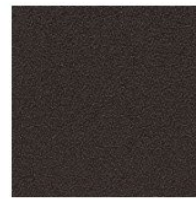

Brownie



Jet Black



Shale



Elephant

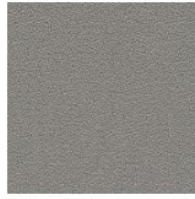

Cinder



Parchment



Mink



Sterling



Chino

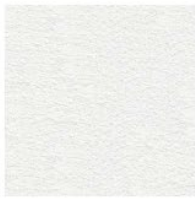

Lunar



Stucco

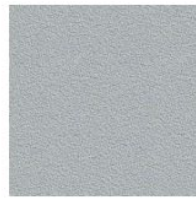

Silverado

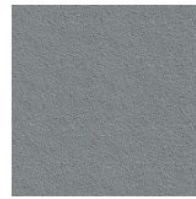

Shark

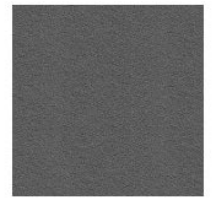

Granite



Academy



Cerulean



Bluestone



Delft



Lichen



Shamrock



Fairway



Ray



Copper



Woodrose

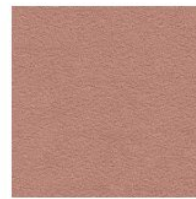

Bloom



Printable